

PROFILE

„That's Automation.“

Planning, Engineering and Manufacturing of Customized Turnkey Plants for the Automation of Production

- Automatic assembly, insertion, packaging and testing machines for automotive, electronics and medical
- Automation equipment for mechatronic systems, sensors, electro-mechanical precision and micro components, injection molding parts and connectors
- Automation modules for manufacture of wafers, cells and PV modules
- Development of handling, buffering and transport systems for thin wafers
- Development from process models to the final assembly of PV thin-film modules

SPONSORED BY THE



Federal Ministry
of Education
and Research

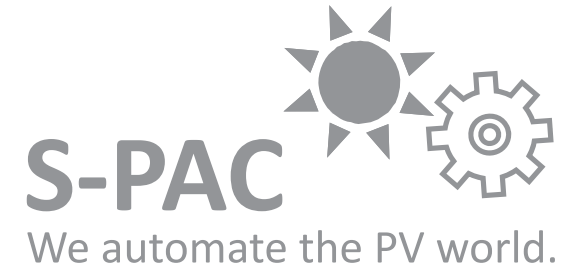
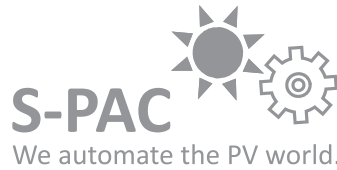

CONTACT

XENON
Automatisierungstechnik GmbH

Heidelberger Str. 1
01189 Dresden

Tel. +49 351 40209 0
Fax +49 351 40209 109

mail@xenon-dresden.de
www.xenon-dresden.de

S-PAC

Saxon Photovoltaic
Automation Cluster

XENON

XENON

PRODUCTS

Innovative Solutions for Flexible or Conventional Solar Cells and Modules

Wafer / Cells

- Transport and Buffering Equipment
- Handling Systems
- Process Evaluation Tools for Measuring Systems
- Industrial Robot Applications

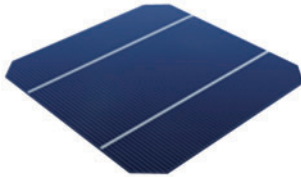

Flexible Cells and Modules

- Separation
- Stringing and Layup
- Bussing / Contacting
- Inspection / Final Test

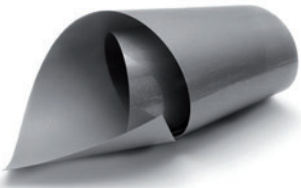

Thin-Film Modules

- Bussing / Contacting
- Sealing
- Assembly / Marriage
- Junction Box Assembly
- Inspection / Final Test

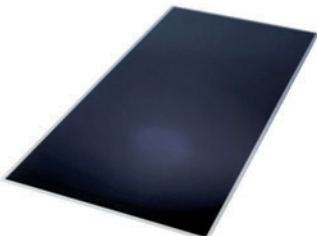

INNOVATIONS



S-PAC Waferhandling

In collaboration with the projectpartner FhG CSP concepts for the minimization of breakage rate in the handling of thin wafers ($<160 \mu\text{m}$) are developed by means of experimental examination, together with numerical models. The functionality of the designed solutions for novel and gentle wafer handlers, manipulators, as well as transport- and buffer units is shown by demonstrators for process modules.

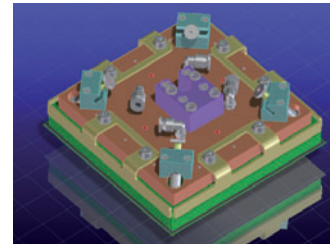

S-PAC Thin-Film Photovoltaics

XENON investigates the back-end part of thin-film module production with regard to its optimization potential to enable lower production costs through use of improved approaches, novel technologies and increased automation. With demonstrators of process modules the testing of the concepts developed in the project is carried out in the fields of bus bar contacting, module assembly, edge sealing and junction box assembly.

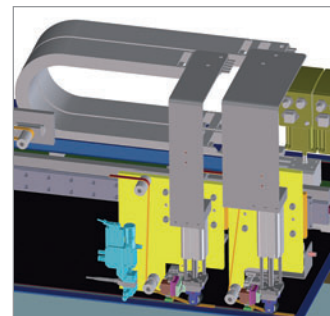

AUTOMATION EQUIPMENT

Fully Automatic Manufacturing and Assembly of Innovative Mechatronic Products



Assembly and Inline Inspection of Pressure Sensors



Modular Contact Insertion Line